

# INSTALLATION INSTRUCTIONS



## **CORKSPORT DISI MZR Exhaust Manifold**

*2007-2013 Mazdaspeed 3 & 2006-2007 Mazdaspeed 6*

**PART #: AXL-6-442-XX**

*Need Help With Your Installation? Call (360)260-CORK*



*We absolutely, positively,  
deliver - every time.*

**CORKSPORT.COM**

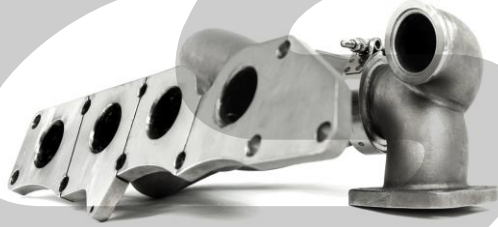

## **CORKSPORT DISI MZR Exhaust Manifold**

2007-2013 Mazdaspeed 3 & 2006-2007  
Mazdaspeed 6

### **PRODUCT DESCRIPTION:**

Thank you for purchasing the CorkSport MZR DISI Exhaust Manifold. By utilizing our unique modular design, we were able to offer a manifold that can adapt as you change your build. The thick wall castings will stand the test of time, while the optimized exhaust collector ensure efficient exhaust scavenging and flow into your turbocharger. We have proven it up to 684WHP with plenty of room to spare and are very excited to see how it performs on your build!

Please let us know your feedback of the by submitting a review at: <https://corksport.com/mazdaspeed-exhaust-manifold.html>

### **PRE-INSTALLATION NOTES:**



You will be removing some complicated components of your vehicle to install this manifold. If you are not comfortable with this or lack the proper tools to do so, please do not proceed.



Verify that your vehicle is completely cooled down prior to starting installation. If you are going to work on your car within an hour or two of driving it, use a fan to cool off the car.



These instructions were written for reference only and the use of a factory service manual is recommended. Most of the installation images shown on 2013 Mazdaspeed 3. Earlier MS3 and MS6 will be similar.



For use with the optional CS EWG dump tube, trimming to the plastic splash shield will be required.

### **MATERIALS & TIME:**

#### GENERAL INFO:



Time Est:  
4hr



Difficulty:  
4/5



CEL:  
No



Warranty:  
2-Year

#### TOOLING LIST:

- 8mm Socket
- 10mm Socket
- 12mm Socket
- 14mm Socket
- 15mm Socket
- 17mm Socket
- 3/8" Drive Ratchet
- 3" Extension
- 6" Extension
- 10mm Wrench
- 12mm Wrench
- 14mm Wrench
- 17mm Wrench
- 3/16" Allen Wrench or Socket
- E8 Reverse Torx Socket
- Flathead Screwdriver
- Jack Stands
- Floor Jack
- O2 Sensor Socket

#### OPTIONAL:

- Electric Drill
- Hole Saw
- 14mm Stubby Wrench
- 17mm Stubby Wrench
- 14mm Crow's Foot
- 17mm Crow's Foot

#### PARTS LIST:

- One (1) CorkSport Manifold Main Section
- One (1) CorkSport OEM Flange Manifold "Elbow" OR
- One (1) CorkSport T3 Flange Manifold "Elbow" OR
- One (1) CorkSport Precision or Tial V-Band Flange Manifold "Elbow"
- One (1) CorkSport MS3 Firewall Heatshield
- One (1) CorkSport 3" V-Band Clamp
- Two (2) M6x1.0 Flange Nuts

#### OPTIONAL:



- One (1) CorkSport EWG Dump Tube Upper Section
- One (1) CorkSport EWG Dump Tube Lower Section
- One (1) CorkSport EWG Dump Tube Clamp

#### ADDITIONAL:

- One (1) Tial 44mm EWG Block-off Plate (if running IWG)
- One (1) Clamp for 44mm EWG Block-off Plate (if running IWG)

# **ORDER OF OPERATIONS & TABLE OF CONTENTS:**

---

	<b>VEHICLE DISASSEMBLY</b>	
	Section 1: 2007-2009 Mazdaspeed 3 Removing OEM Hood and Cowl	Pg. 4-7
	Section 2: 2010-2013 Mazdaspeed 3 Removing OEM Hood and Cowl	Pg. 8-11
	Section 3: 2006-2006 Mazdaspeed 6 Removing OEM Hood and Cowl	Pg. 12-15
	Section 4: Removing the OEM Intake	Pg. 16-17
	Section 5: Removing the Battery Box & ECU	Pg. 17-19
	Section 6: Removing the OEM Turbo Inlet Pipe	Pg. 19-20
	Section 7: Removing the OEM TMIC	Pg. 20-21
	Section 8: Removing the OEM Heatshields	Pg. 22
	Section 9: Removing the OEM Exhaust Manifold	Pg. 23
	<b>CORKSPORT EXHAUST MANIFOLD INSTALLATION</b>	
	Section 10: Installing the CorkSport Exhaust Manifold Main Section	Pg. 24-29
	Section 11: Installing the CorkSport Exhaust Manifold Elbow Section	Pg. 30-31
	Section 12: CorkSport Exhaust Manifold Setup for IWG	Pg. 32
	Section 13: CorkSport Exhaust Manifold Setup for EWG	Pg. 33-35
	<b>VEHICLE REASSEMBLY</b>	
	Section 14: Vehicle Reassembly and First Startup	Pg. 36

## DETAILED INSTRUCTIONS:

### 1. 2007-2009 Mazdaspeed 3 Removing OEM Hood and Cowl



2010-2013 Mazdaspeed 3 owners skip to section 2 on page 8.  
2006-2007 Mazdaspeed 6 owners skip to Section 3 on page 12.



GEN 1 Hood and Cowl Removal is optional. However, we strongly recommend removing the hood and cowl as it allows for easier access during installation.



Hood removal can easily damage the paint of your vehicle if you are not careful. We strongly recommend having a friend help during hood removal.

- a) Lift up the hood and remove the two 12mm bolts located near the back corners of the hood. Support the hood upon bolt removal to ensure it does not bend the hinges. One bolt location circled in red in Figure 1a the opposite side of the hood is identical.
- b) Loosen the remaining two 12mm bolts holding the hood to the hinges. These do not need to be completely removed. One bolt location circled in blue in Figure 1a.
- c) Slide the hood free from the hinges and remove the hood from the vehicle. Store the hood in a secure place, safe from damage or chance of bending the corners.
- d) Remove the wiper arm bolt covers by prying them off using a flathead screwdriver. Shown removed in Figure 1b.
- e) Unbolt the wiper arms from the vehicle using a 12mm socket and ratchet. Bolt locations circled in red in Figure 1b.
- f) Remove the wiper arms from the vehicle. They can get stuck and require some effort to remove.



Figure 1a



Figure 1b

## DETAILED INSTRUCTIONS:

### 1. 2007-2009 Mazdaspeed 3 Removing OEM Hood and Cowl (cont.)

- g) Remove the rubber rear hood seal by undipping the 8 clips that hold it to the cowl. These clips typically pull free with the rubber, but may need to be squeezed from underneath if they do not easily come free. Locations **shown in red** in **Figure 1c**.



Figure 1c

- h) Remove the two covers in the corners of the plastic cowl. They should easily pry free. Shown removed with **red circles** in **Figure 1d**.



Figure 1d

- i) Remove the Phillips head screws in the corners of the plastic cowl. Shown with **red circles** in **Figure 1d**.
- j) Disconnect the windshield washer fluid line at the left side of the cowl. Pull the hose sections apart at the white joint **circled in blue** in **Figure 1d**. Also shown in **blue** in **Figure 1e** on the next page. Secure the line coming from the fender so it does not fall down into the fender.

## DETAILED INSTRUCTIONS:

### 1. 2007-2009 Mazdaspeed 3 Removing OEM Hood and Cowl (cont.)

k) Unclip the two tabs located near the ends of the cowl. Location shown with **green arrows** in **Figure 1d** and shown up close with a **red circle** in **Figure 1e**. You can reach underneath the edge of the cowl to release these clips.

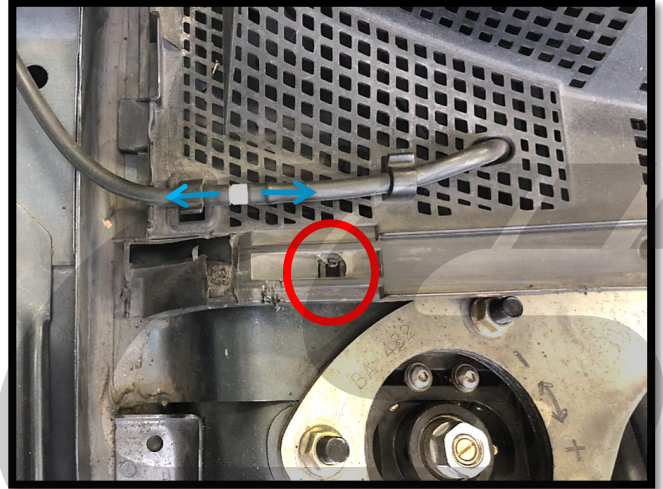

**Figure 1e**

l) Remove the plastic portion of the cowl from the vehicle. It will pull free from underneath the windshield and it will need to be guided off the windshield wiper posts. Be patient to ensure you do not damage the cowl.

m) Remove the drip tray from the metal portion of the cowl. Use a Phillips screwdriver to remove the three screw type push clips, shown **circled in red** in **Figure 1f**. Then unclip the three retaining clips from the front of the drip tray, shown **circled in blue** in **Figure 1f**. Then remove the plastic drip tray from the vehicle.

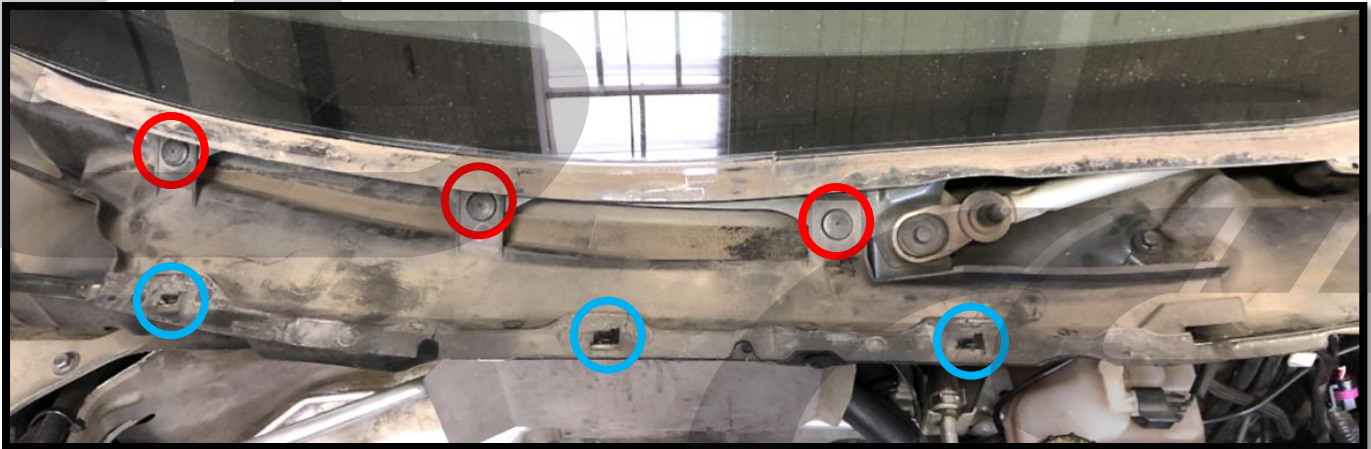

**Figure 1f**

## **DETAILED INSTRUCTIONS:**

### **1. 2007-2009 Mazdaspeed 3 Removing OEM Hood and Cowl (cont.)**

- n) Remove the eleven 10mm bolts that attach the metal portion of the cowl to the vehicle. Bolts are shown with red in Figures 1g and 1h. The metal portion of the cowl can then be removed from the vehicle.



Figure 1g shows the bolt locations on the passenger side of the cowl while Figure 1h shows the bolt locations on the driver side of the cowl.



**Figure 1g**

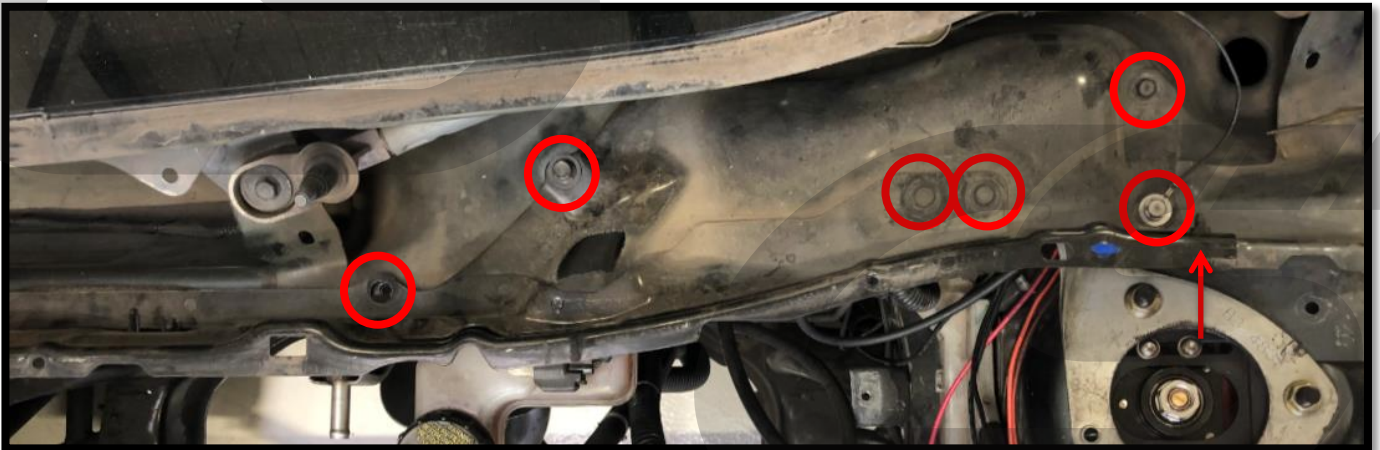

**Figure 1h**

## DETAILED INSTRUCTIONS:

### 2. 2010-2013 Mazdaspeed 3 Removing OEM Hood and Cowl



2007-2009 Mazdaspeed 3 owners skip to section 4 on page 16.  
2006-2007 Mazdaspeed 6 owners skip to Section 3 on page 12.



GEN 2 Hood Removal is optional. However, we strongly recommend removing the hood as it allows for easier access during installation. These instructions are shown keeping the hood on the vehicle.



Hood removal can easily damage the paint of your vehicle if you are not careful. We strongly recommend having a friend help during hood removal.

- a) Lift up the hood and remove the two 12mm bolts located near the back corners of the hood. Support the hood upon bolt removal to ensure it does not bend the hinges. Bolt locations **shown in red** in **Figure 2a**.
- b) Loosen the remaining two 12mm bolts holding the hood to the hinges. These do not need to be completely removed. Bolt locations **shown in blue** in **Figure 2a**.
- c) Slide the hood free from the hinges and remove the hood from the vehicle. Store the hood in a secure place, safe from damage or chance of bending the corners.
- d) Remove the wiper arm bolt covers by prying them off using a flathead screwdriver. Shown **circled in green** in **Figure 2a**.
- e) Unbolt the wiper arms from the vehicle using a 12mm socket and ratchet. Bolt locations **circled in green** in **Figure 2a**.
- f) Remove the wiper arms from the vehicle. They can get stuck and require some effort to remove.

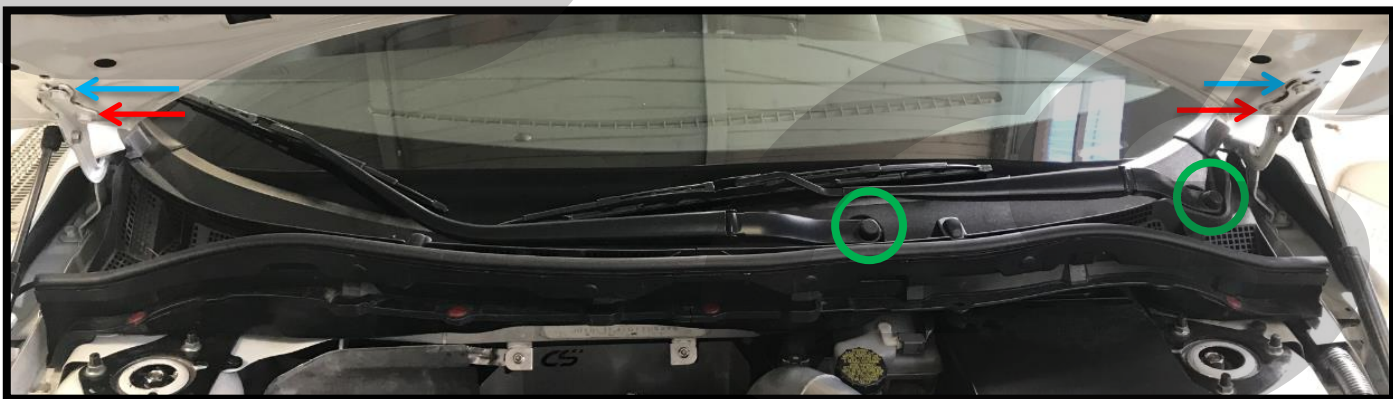

Figure 2a



**DETAILED INSTRUCTIONS:**

**2. 2010-2013 Mazdaspeed 3 Removing OEM Hood and Cowl (cont.)**

- g) Remove the five red push clips that hold the plastic portion of the cowl to the vehicle. Shown **circled in red** in **Figure 2b**.



**Figure 2b**

- h) Disconnect the windshield washer fluid line at the left side of the cowl. Pull the hose sections apart at the joint **shown in blue** in **Figure 2b**. Also shown in **blue** in **Figure 2c**. Secure the line coming from the fender so it does not fall down into the fender.

- i) Then, remove the plastic portion of the cowl from the vehicle.

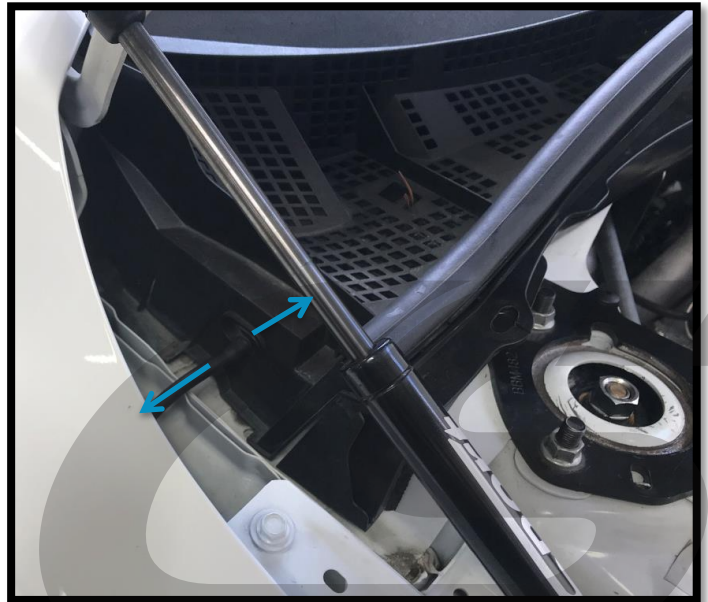
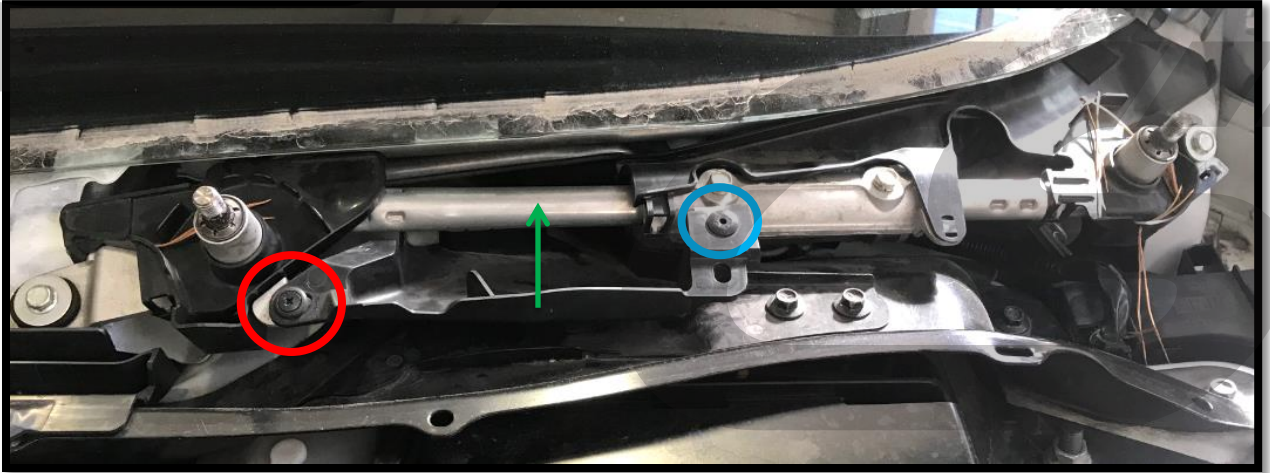

**Figure 2c**

## **DETAILED INSTRUCTIONS:**

### **2. 2010-2013 Mazdaspeed 3 Removing OEM Hood and Cowl (cont.)**

- j) Remove the screw type push clip from the drip tray on the wiper motor. **Circled in red** in **Figure 2d**.



**Figure 2d**

- k) Pull the drip tray free from the wiper motor in the direction shown with the **green arrow** in **Figure 2d**. The clip **circled in blue** in **Figure 2d** will pop free with a little effort.
- l) Remove the three push clips holding the drip tray to the metal portion of the cowl. **Circled in red** in **Figure 2e**.
- m) Remove the three Phillips head screws holding the drip tray to the metal portion of the cowl. **Circled in blue** in **Figure 2e**. Then remove the drip tray from the vehicle.

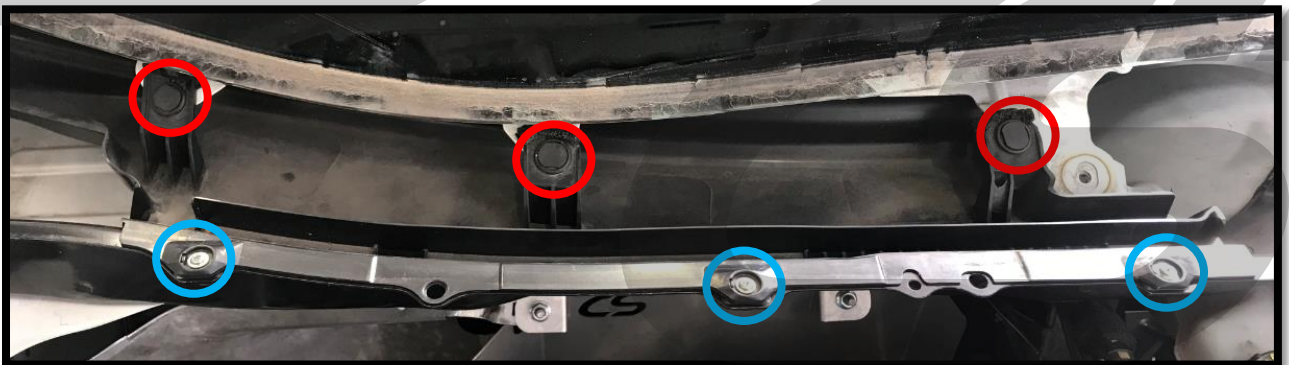

**Figure 2e**

## **DETAILED INSTRUCTIONS:**

### **2. 2010-2013 Mazdaspeed 3 Removing OEM Hood and Cowl (cont.)**

- n) Remove the eleven 12mm bolts that hold the metal portion of the cowl to the vehicle. Bolts shown **circled in red** in **Figure 2f** and **Figure 2g**. Passenger side of the cowl shown in **Figure 2f**, driver side in **Figure 2g**.



For clarity the driver's side portion of the cowl is shown with the wiper motor removed. You can access all bolts with wiper motor installed, but drip tray removed, as performed in Step 2k.

- o) Remove the metal portion of the cowl from the vehicle.



**Figure 2f**

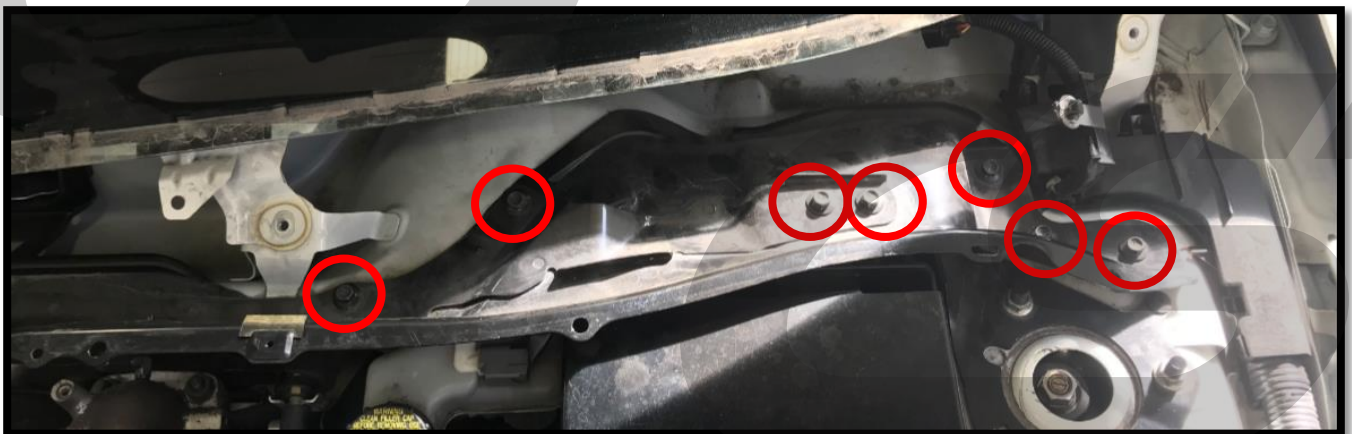

**Figure 2g**

## DETAILED INSTRUCTIONS:

### 3. 2006-2007 Mazdaspeed 6 Removing OEM Hood and Cowl



2007-2009 Mazdaspeed 3 owners skip to section 4 on page 16.  
2010-2013 Mazdaspeed 3 owners skip to Section 4 on page 16.



MS6 Hood Removal is optional. However, we strongly recommend removing the hood as it allows for easier access during installation.



Hood removal can easily damage the paint of your vehicle if you are not careful. We strongly recommend having a friend help during hood removal. The MS6 is also very heavy so be careful.

- Lift up the hood and remove the two 12mm bolts located near the back corners of the hood. Support the hood upon bolt removal to ensure it does not bend the hinges. One bolt location circled in red in Figure 3a the opposite side of the hood is identical.
- Loosen the remaining two 12mm bolts holding the hood to the hinges. These do not need to be completely removed. One bolt location shown in blue in Figure 3a.
- Slide the hood free from the hinges and remove the hood from the vehicle. Store the hood in a secure place, safe from damage or chance of bending the corners.

- Remove the wiper arm bolt covers by prying them off using a flathead screwdriver. Shown circled in red in Figure 3b.
- Unbolt the wiper arms from the vehicle using a 12mm socket and ratchet. Bolt locations circled in red in Figure 3b.
- Remove the wiper arms from the vehicle. They can get stuck and require some effort to remove.

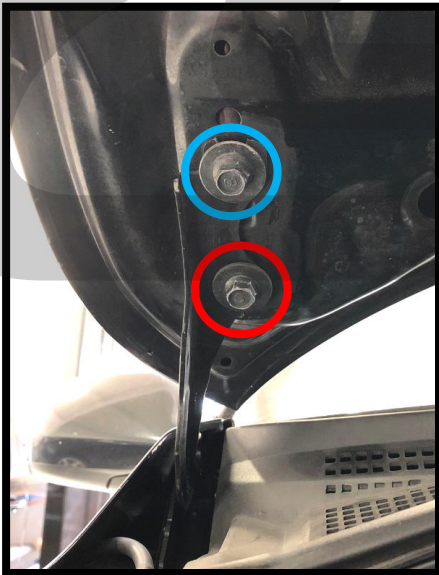

Figure 3a

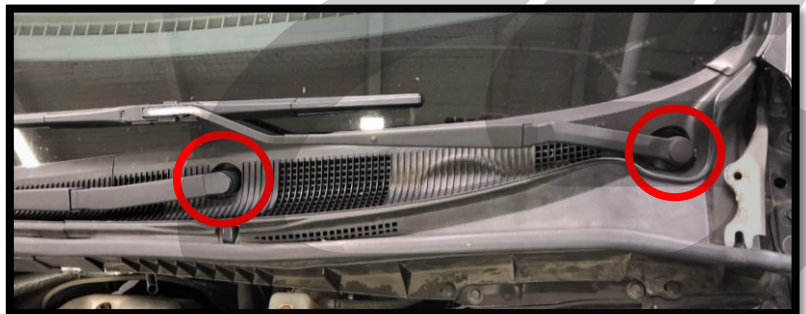
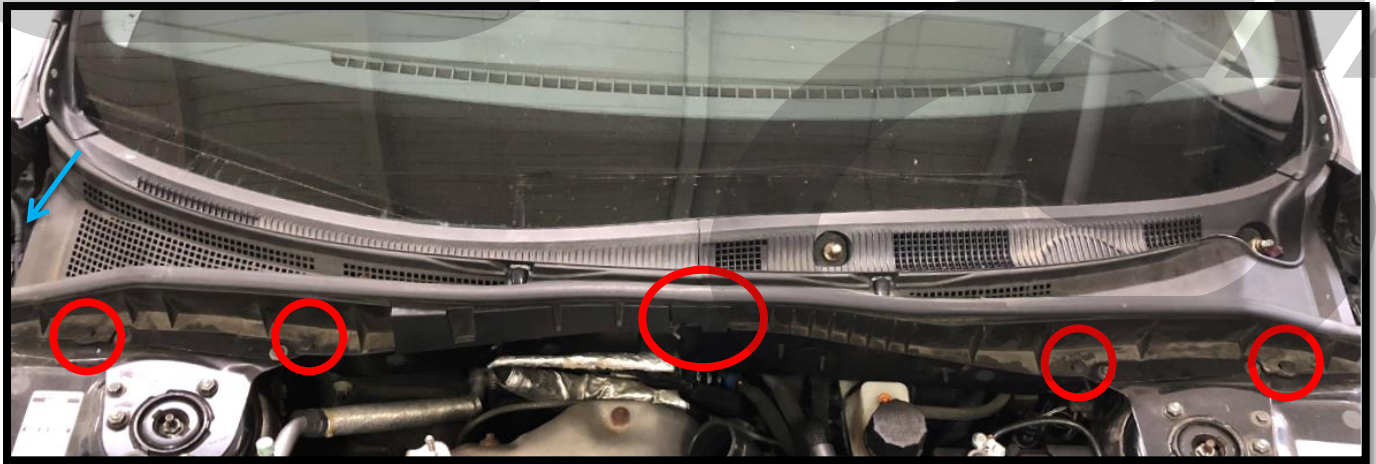

Figure 3b

**DETAILED INSTRUCTIONS:****3. 2006-2007 Mazdaspeed 6 Removing OEM Hood and Cowl (cont.)**

- g) Remove the five push clips that hold the plastic portion of the cowl to the vehicle. Shown **circled in red** in **Figure 3c**. Please note: there is a push clip behind the rectangular plastic cover in the center of the cowl. Typically, this clip can be released without removing the cover. If the cover must be removed, use care to not break the plastic as it can be fragile.

**Figure 3c**

- h) Disconnect the windshield washer fluid line at the left side of the cowl. Pull the hose sections apart at the joint **shown in blue** in **Figure 3c**. Also shown in **blue** in **Figure 3d**. Secure the line coming from the fender so it does not fall down into the fender.

**Figure 3d**

- i) Then, remove the plastic portion of the cowl from the vehicle.

**DETAILED INSTRUCTIONS:****3. 2006-2007 Mazdaspeed 6 Removing OEM Hood and Cowl (cont.)**

- j) Remove the two 10mm bolts that connect the wiper motor assembly to the metal portion of the cowl. Bolt locations **circled in red** in **Figure 3e**.
- k) Unplug the wiper motor assembly. The plug is **circled in blue** in **Figure 3e**.
- l) Remove the wiper motor assembly from the vehicle.



Use extreme caution when removing the wiper motor from underneath the windshield. The edge of the windshield can chip or crack very easily so avoid contact with the windshield whenever possible.

**Figure 3e**

- m) Remove the three 10mm bolts that attach the center cowl brace to the vehicle. **Shown in red** in **Figure 3f**. Then remove the cowl brace from the vehicle.

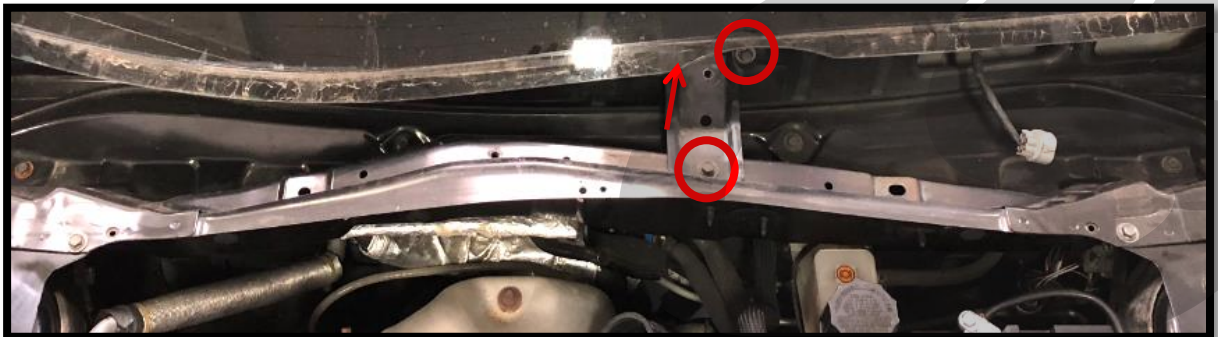
**Figure 3f**

**DETAILED INSTRUCTIONS:**

**3. 2006-2007 Mazdaspeed 6 Removing OEM Hood and Cowl (cont.)**

- n) Remove the ten 10mm bolts that hold the metal portion of the cowl to the vehicle. Bolts shown circled in red in **Figure 3g** and **Figure 3h**. Passenger side of the cowl shown in **Figure 3g**, driver side in **Figure 3h**.
  
- o) Remove the metal portion of the cowl from the vehicle.

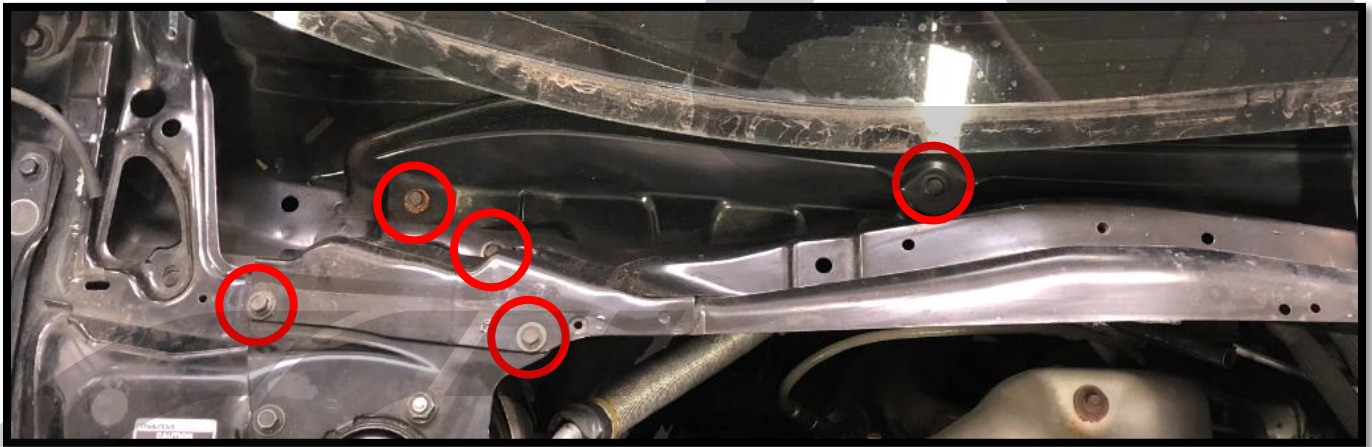

**Figure 3g**

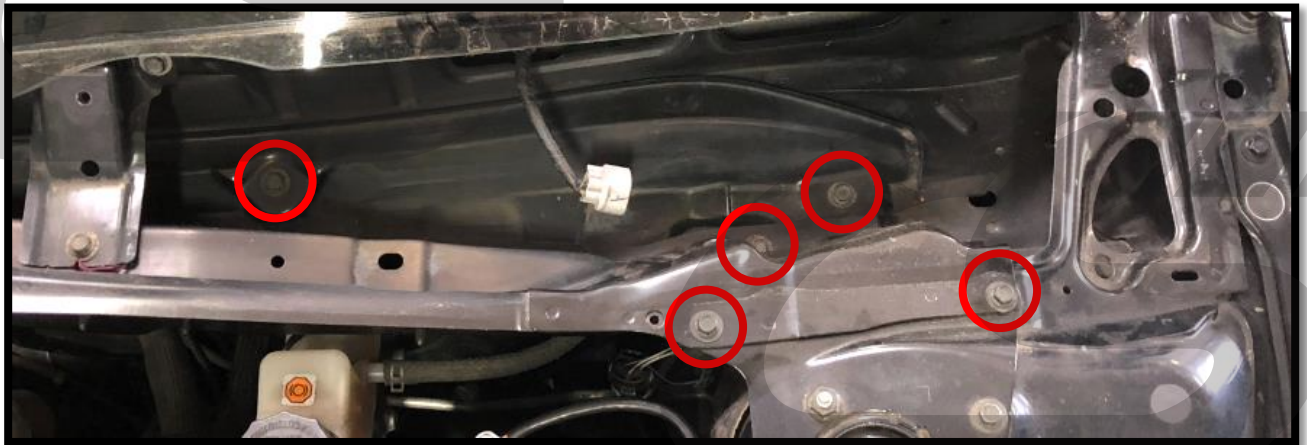

**Figure 3h**

## DETAILED INSTRUCTIONS:

### 4. Removing the OEM Intake



We strongly recommend a sharpie and plastic bags to label all hardware throughout install.

- a) Remove the top mount intercooler (TMIC) cover by removing the two 10mm bolts (red circles in Figure 4a).
- b) Loosen the two (2) 10mm hose clamps on the factory rubber intake elbow (red circles in Figure 4b).
- c) Pull the OEM intake elbow off the OEM turbo inlet pipe. Pull in direction shown with green arrow in Figure 4b.
- d) Unplug the MAF sensor located on the air filter housing (green circle in Figure 4c).
- e) Remove the two 10mm bolts on the air filter housing bracket and remove the bracket (red circles in Figure 4c).



Mazdaspeed 6 does not have the bolts referenced in step 1e. Skip this step if you have an MS6.

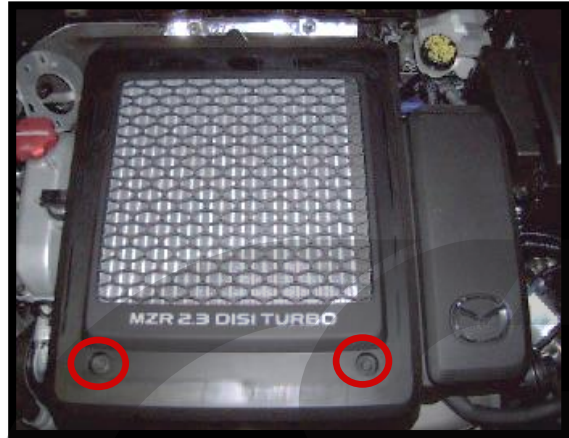

Figure 4a

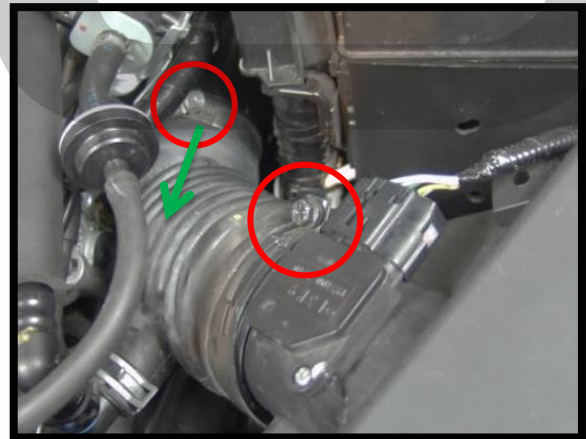

Figure 4b

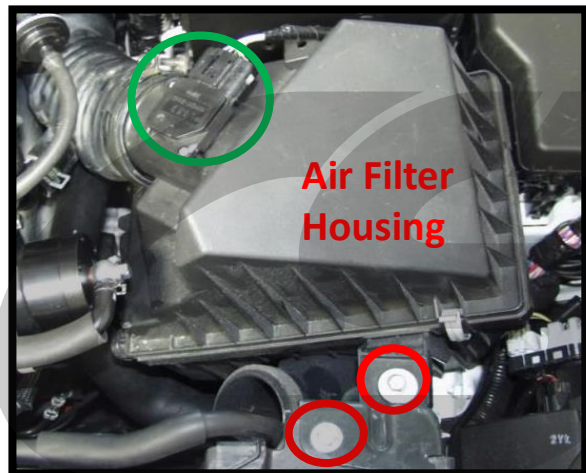

Figure 4c



## DETAILED INSTRUCTIONS:

### 4. Removing the OEM Intake (continued)

- f) **Remove the valve cover breather tube.** Push the hose connector toward the valve cover and press both sides of the colored clip simultaneously. Pull the hose away from the valve cover (**Figure 4d**).
  
- g) **Pull up on the filter housing** to pop it free from the car and remove it along with the intake elbow and breather tube.

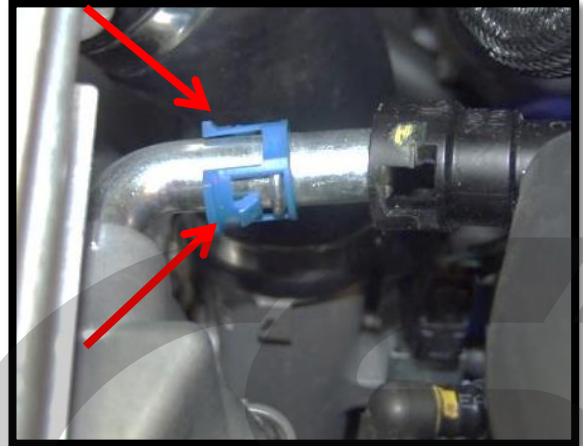

Figure 4d

### 5. Removing the Battery Box & ECU



Mazdaspeed 6 has a battery tray instead of a battery box. Also, the ECU does not need to be removed. **Only follow steps 5b, 5c, and 5g for battery tray removal if installing on MS6.**

- a) **Remove the battery box cover.** The cover is held on with two clips (shown with **red arrows** in **Figure 5a**). Pry the clips outward by hand and lift the front of the lid off of the box. The **green arrow** in **Figure 5a** shows the location of the ECU.

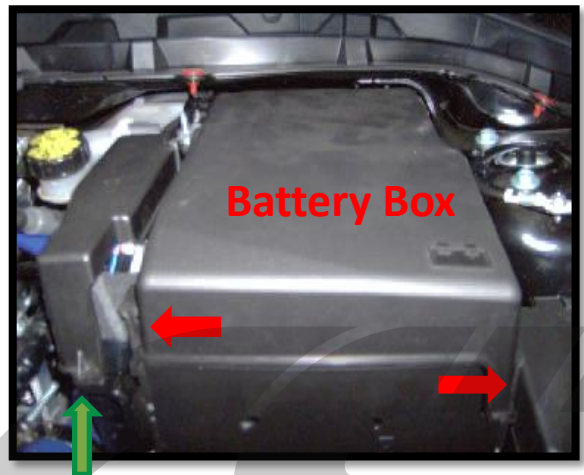

Figure 5a

## DETAILED INSTRUCTIONS:

### 5. Removing the Battery Box & ECU (cont.)

- b) **Disconnect the battery.** Disconnect the battery terminals with a 10mm end wrench. Refer to **Figure 5b** for negative (-) and positive (+) terminals. Disconnect the negative terminal of the battery first, then the positive terminal (**Figure 5b**).
- c) **Remove the two 10mm nuts for the battery tie down bracket** (shown with **red circles** in **Figure 5b**).
- d) **Remove the battery from the battery box.**
- e) **Remove the front battery box panel.** Remove the MAF wiring harness clip (**blue circle Figure 5c**), and negative battery cable clip (**purple circle Figure 5c**), from the front battery box panel using needle nose pliers to compress the clips on the inside of the battery box. Then slide the panel upwards and remove it (**green arrow in Figure 5c**).
- f) **Disconnect the ECU plugs** by pushing on the tabs (**red arrows in Figure 5d**) and pulling the white lock upward simultaneously (**green arrows in Figure 5d**). Refer to **Figure 5b** for location of ECU plugs and **Figure 5d** for close ups.



Do not force the ECU plugs. When done correctly, they will come apart very easily.

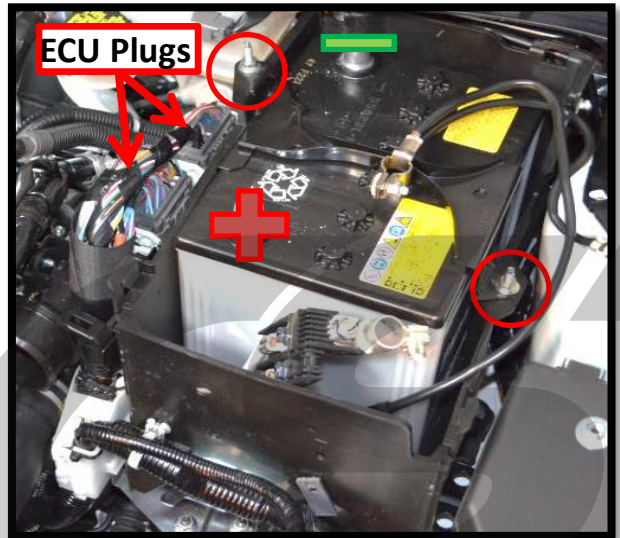

Figure 5b

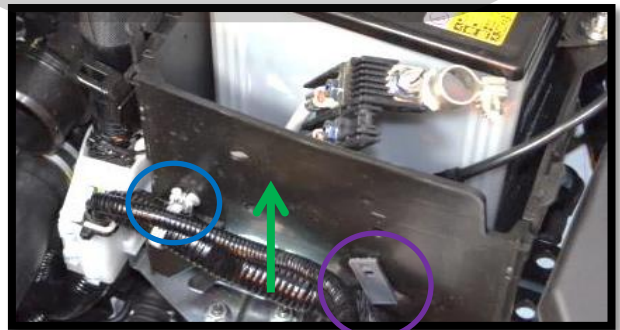

Figure 5c

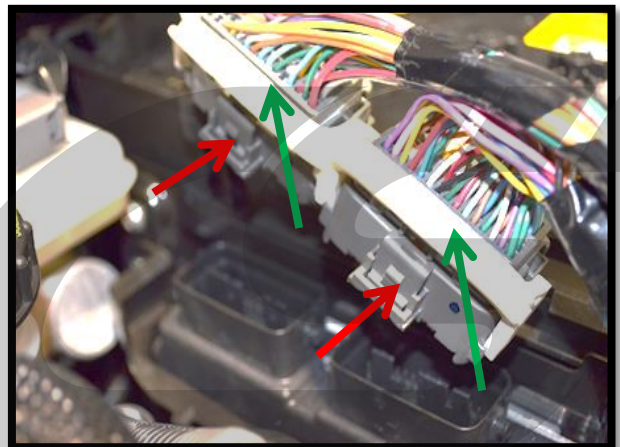

Figure 5d

## DETAILED INSTRUCTIONS:

### 5. Removing the Battery Box & ECU (cont.)

- g) Remove the battery box. Remove the three 10mm bolts in the bottom of the box, and remove the battery box and ECU (red circles Figure 5e).



Mazdaspeed 6 vehicles have two (2) 10mm bolts holding the battery tray instead of three (3). In addition, you must release the wiring harness clip at the front of the battery tray for removal.

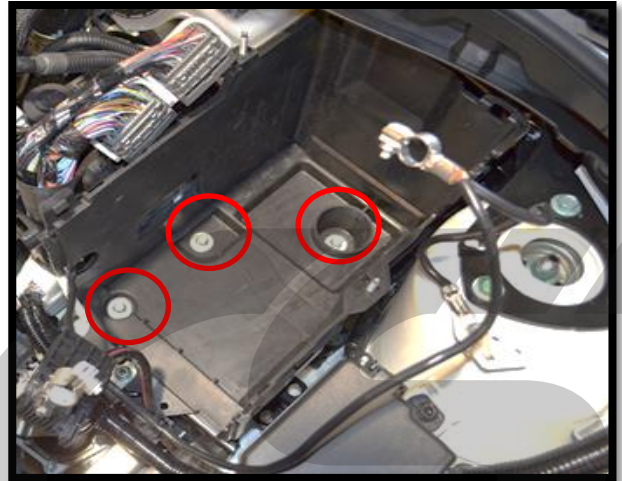

Figure 5e

### 6. Removing the OEM Turbo Inlet Pipe (TIP)

- a) Release the hose clamps on the bypass valve hose (red circles in Figure 6a) using channel lock pliers. Remove the BPV hose from the car and save if you are re-using it. You can discard the rubber hose and spring clamps if you will be installing the CorkSport Silicone BPV Hose.

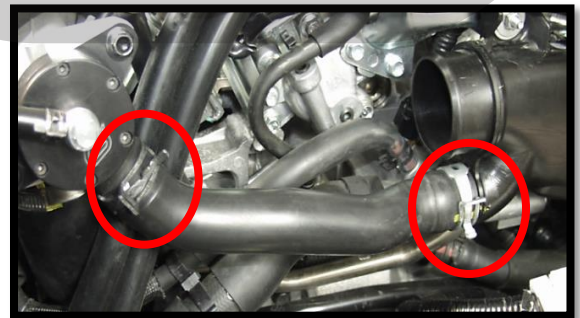

Figure 6a

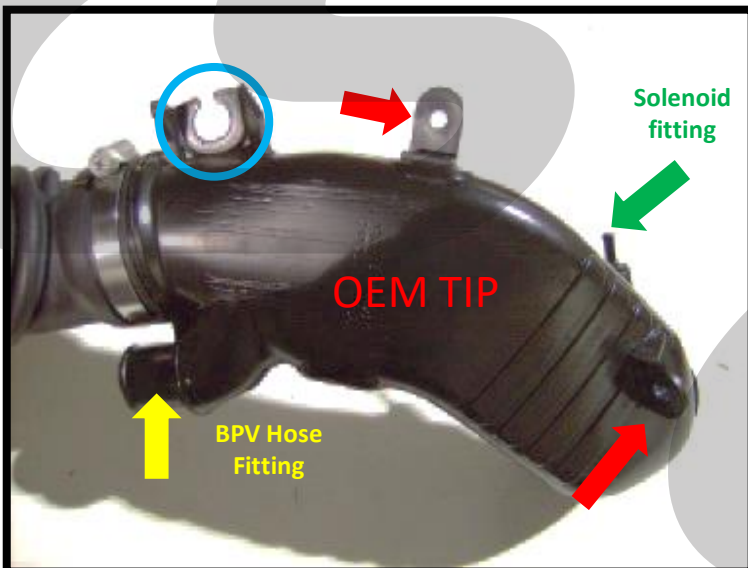

Figure 6b

- b) Remove the 10mm nut that holds the stock turbo inlet pipe in place (blue circle in Figure 6b).

- c) Remove the two wiring harness clips (red arrows in Figure 6b) located on the stock turbo inlet pipe.

## **DETAILED INSTRUCTIONS:**

### **6. Removing the OEM TIP (cont.)**



Use extreme caution when performing the next step. The plastic barb can break off very easily.

- d) Using needle nose pliers, release the small spring clamp from solenoid fitting on the OEM TIP (see the green arrow in Figure 6b on the previous page). Then remove the small hose from this same fitting.



If you are having difficulty this hose loose, try rotating the hose to break the seal of the rubber to the plastic fitting and then pulling straight up. It takes a little force but cleanly comes off.

- e) Remove the plastic inlet pipe from the turbocharger. Loosen the 10mm hose clamp at the turbo inlet, pull the OEM TIP off of the turbocharger, and remove it from the car.

### **7. Removing the OEM Top Mount Intercooler (TMIC)**

- a) Remove the clamps for the throttle body and turbo boost tubes from the intercooler. Use a 10mm socket to loosen the clamps (red circles in Figure 7a).

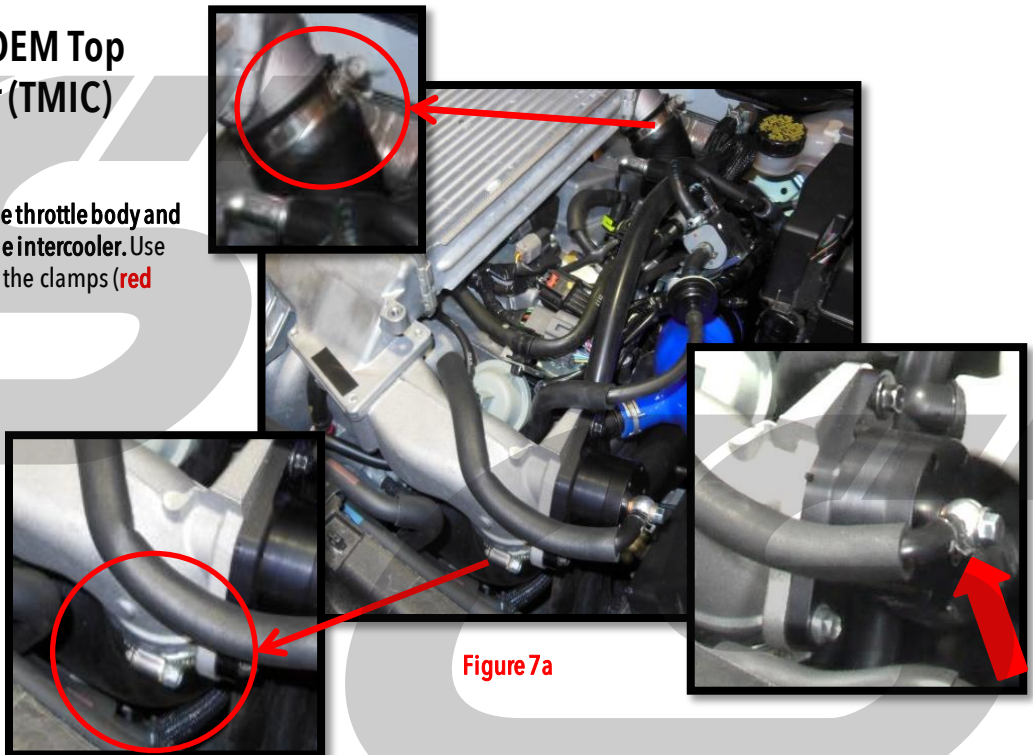

## DETAILED INSTRUCTIONS:

### 7. Removing the OEM TMIC (cont.)

- b) Detach the bypass valve (BPV) signal hose from the BPV. Release the spring clamp and then remove the signal hose from the BPV (red arrow in Figure 7a on previous page). Leave the bypass valve attached to the intercooler pipe.
- c) Remove the three (3) 12mm nuts fastening the intercooler to the top of the engine (red circles in Figure 7b).
- d) Remove the OEM intercooler from the vehicle by pulling upwards to release it from the boost tubes & mounting studs.
- e) Remove the outlet boost tube from the turbocharger. Use a 10mm socket and ratchet or #2 Phillips screwdriver. See red circle in Figure 7c.

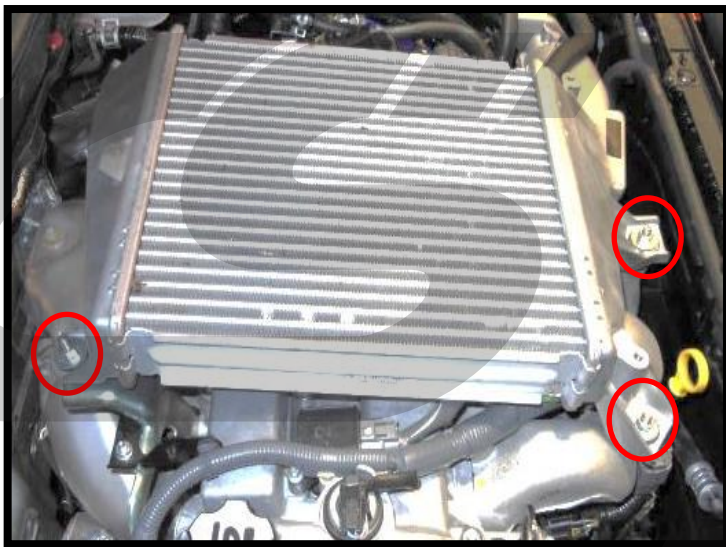

Figure 7b



Figure 7c

## DETAILED INSTRUCTIONS:

### 8. Removing the OEM Heatshields

- a) Remove thin silver firewall heat shield shown with the green arrow in Figure 8a. There are three plastic clips that unscrew.



Mazdaspeed 6 vehicles do not have this heatshield.

- b) Remove the six 8mm bolts circled in red in Figure 8a, then remove the upper heat shield.

- c) Remove the three 8mm bolts holding the lower heat shield shown with the red circles in Figure 8b. Then remove the heatshield.

- d) Remove the three 8mm bolts from the turbine housing heatshield. Shown in red in Figure 8b. Note, the bolt shown with the arrow is on the underside of the turbo and is difficult to see from the top side.

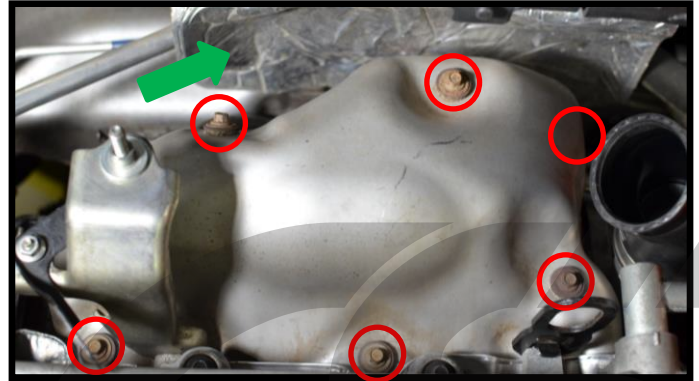

Figure 8a

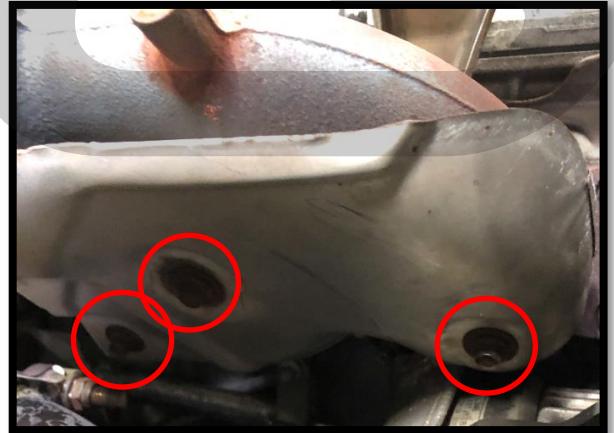

Figure 8b

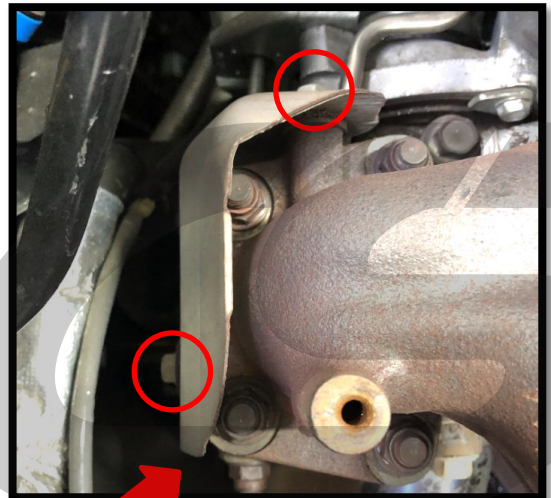

Figure 8c

## DETAILED INSTRUCTIONS:

### 9. Removing the OEM Exhaust Manifold

- a) Remove the 8mm bolt that secures the oil feed line to the OEM manifold. **Circled in red in Figure 9a.** It is located below the cylinder 2 runner, near the downpipe O2 sensor.
- b) Remove the four 14mm nuts that attach the OEM exhaust manifold to the turbocharger. **Circled in red in Figure 9b.**
- c) **Optional:** Remove the OEM lifting eye and rear TMIC mount by removing the three 14mm bolts **shown in red in Figure 9c.** If your vehicle has wiring clipped to the TMIC mount, you will need to unclip this wiring. This step is optional but does allow extra clearance when removing the OE manifold.
- d) Remove the ten 14mm nuts that attach the OEM manifold to the engine. Shown numbered in **Figure 9d.** Order does not matter during removal. Then remove the OEM exhaust manifold from the vehicle.



Figure 9a

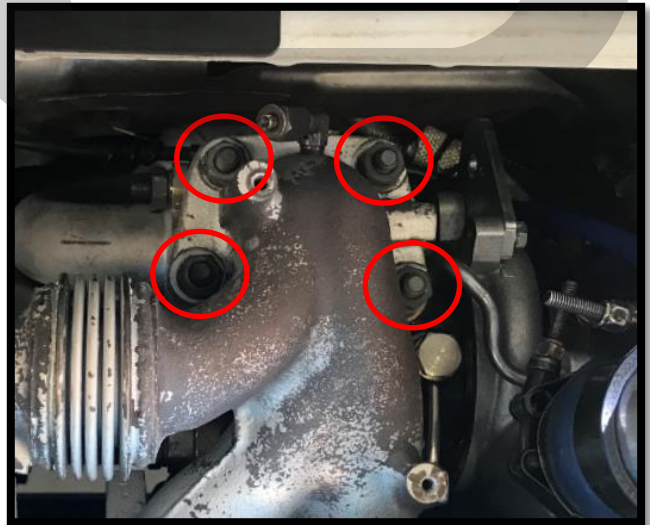

Figure 9b

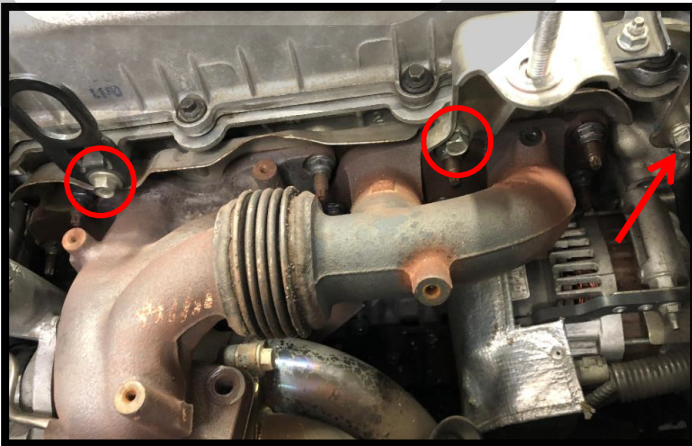

Figure 9c

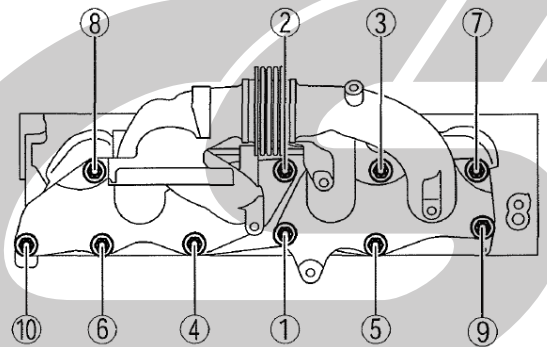

Figure 9d

**DETAILED INSTRUCTIONS:****10. Installing the CorkSport Exhaust Manifold Main Section**

- a) Using an E8 external Torx socket, remove the top row of exhaust manifold studs. Use a small ratchet and extreme caution on these studs to prevent breaking or bending them. E8 socket and top row of studs shown removed in **Figure 10a**. Referencing **Figure 9d**, we recommend removing studs 2, 3, 7, and 8 (the top row).

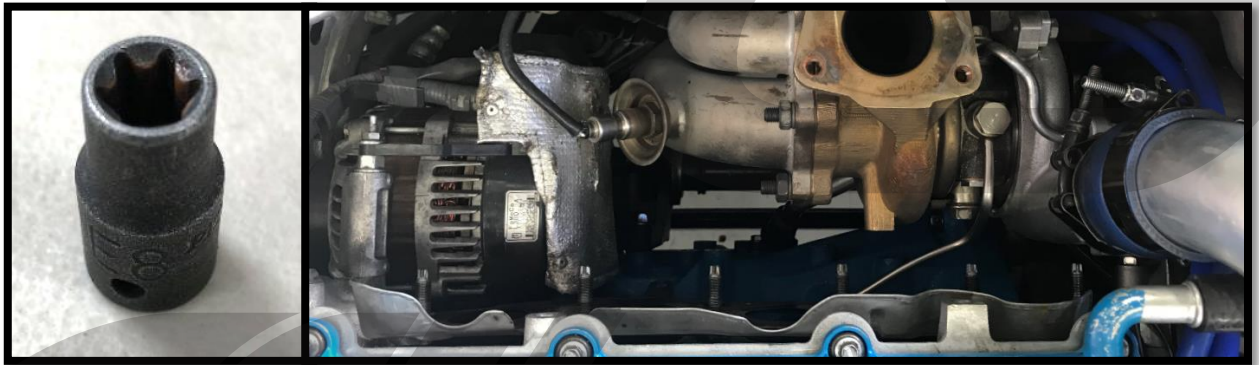

The CS manifold can be installed without removing any studs however it is very difficult with a turbo in position. If you do not wish to remove studs, you will at minimum need to unbolt your lower turbo support bracket to give you a little extra wiggle room when installing the CS manifold. More disassembly may be necessary if you do not remove studs.

**Figure 10a**

- b) Install the center upper stud and nut onto the manifold as shown **circled in red** in **Figure 10b**. This stud in this location cannot be easily reinstalled with the manifold positioned on the engine. All others are easy to reinstall with the manifold on the engine. This is location #2 in **Figure 9d**.

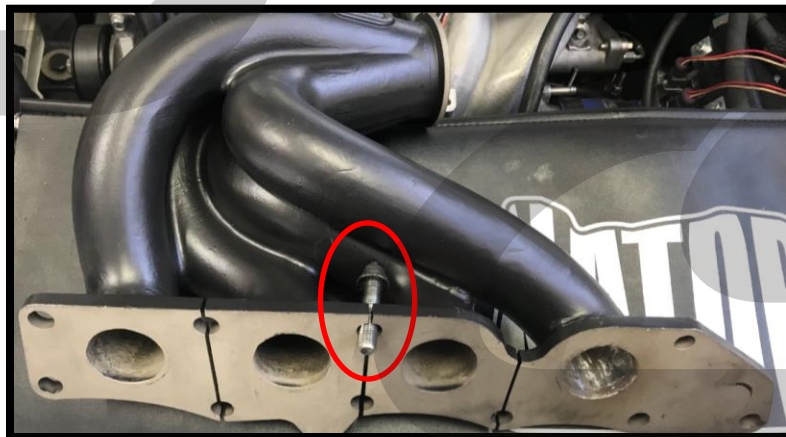



**DETAILED INSTRUCTIONS:****10. Installing the CorkSport Exhaust Manifold Main Section (cont.)**

- c) Loosen the three 14mm bolts on the turbochargers support bracket located underneath the turbo. This will allow for some extra movement during install.
- d) Lift the CS exhaust manifold onto the remaining studs and into position as shown in **Figure 10c**. If having difficulty getting the manifold in position, removing more studs and/or unbolting the lower turbo support bracket will give you the clearance you need.
- e) Hand thread in any studs removed during step 10a and 10c. The studs should thread in until the "stop" located in the center of the stud. If they seem difficult to thread in, a small ratchet and the E8 socket can be used with very light torque to reinstall the studs if needed.
- f) Hand thread on the OEM manifold nuts. Leave loose for now.

**Figure 10c**

- g) Hand tighten all 10 OEM manifold nuts, then **torque to 32-47ft-lbs** following the orders shown in **Figure 10d**.

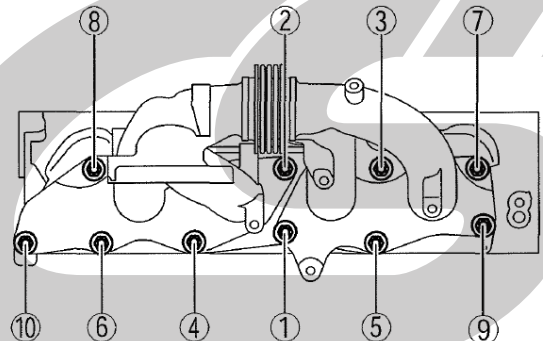
**Figure 10d**

## **DETAILED INSTRUCTIONS:**

### **10. Installing the CorkSport Exhaust Manifold Main Section (cont.)**

- h) Reinstall the oil feed line bracket removed in Step 9a to the CS exhaust manifold using the OEM 8mm bolt. Tighten until snug.



The following images are a guide for tightening the manifold nuts with the CS exhaust manifold. These images were taken on a MS6 which has the most difficult access. MS3 GEN1 and GEN2 can access a lot of the nuts from underneath the car as there is no transfer case in the way.



**Nut 1: 14mm deep socket, short extension, ratchet (short or bent handle works best)**



**Nut 2: Basic 14mm wrench. Use caution to not damage exhaust manifold gasket.**

**DETAILED INSTRUCTIONS:**

**10. Installing the CorkSport Exhaust Manifold Main Section (cont.)**



**Nut 3:** Basic 14mm wrench. Use caution to not damage exhaust manifold gasket.

**Nut 4:** Basic 14mm wrench or short ratcheting wrench. Reach underneath manifold from passenger side of car.

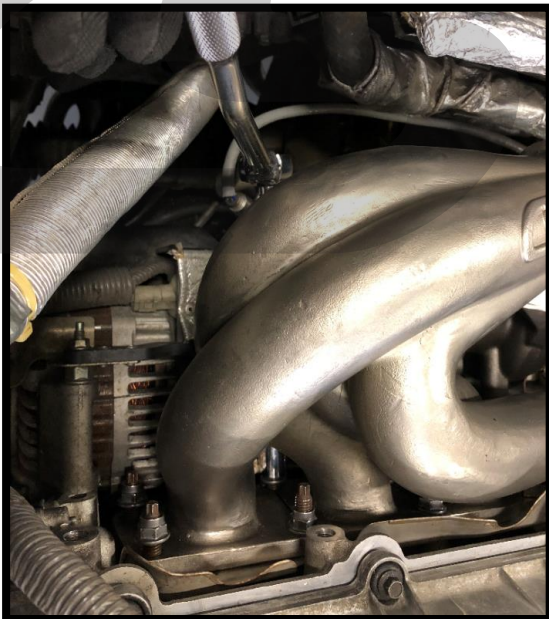

**Nut 5:** 14mm deep socket, long extension, ratchet

**DETAILED INSTRUCTIONS:**

**10. Installing the CorkSport Exhaust Manifold Main Section (cont.)**

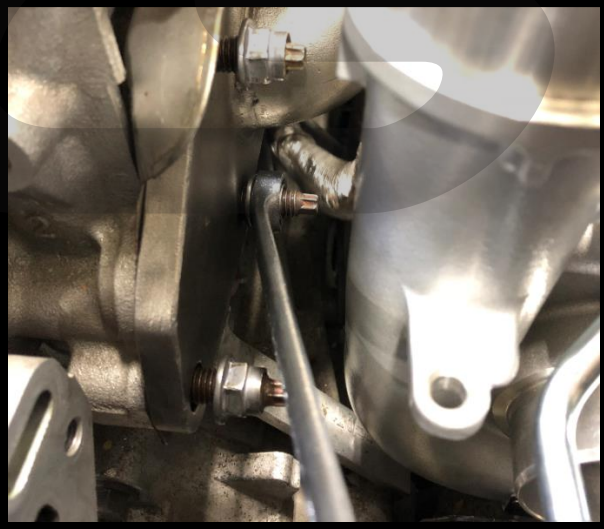

Removal of the EGR Valve is not necessary for access to the studs/nuts, but is helpful. For removal reference these instructions:



<https://corksport.com/support/instructions/GEN-6-531-WEB.pdf>

**Nut 6:** Basic 14mm wrench. Reach from driverside of car.

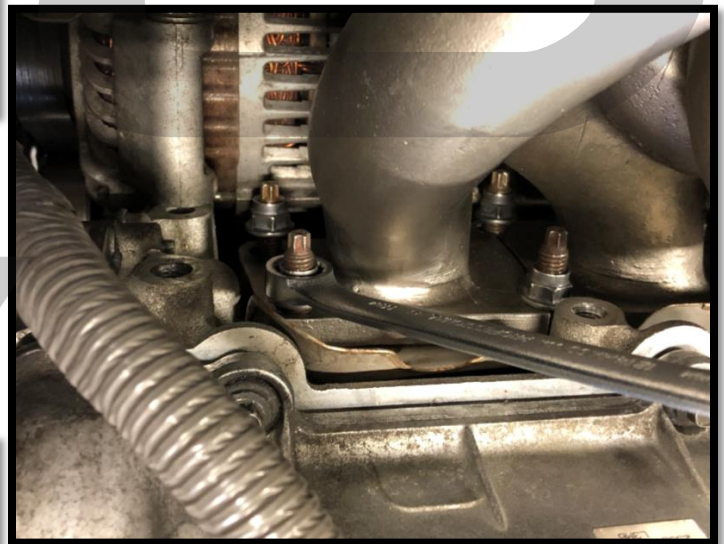

**Nut 7:** Basic 14mm wrench.

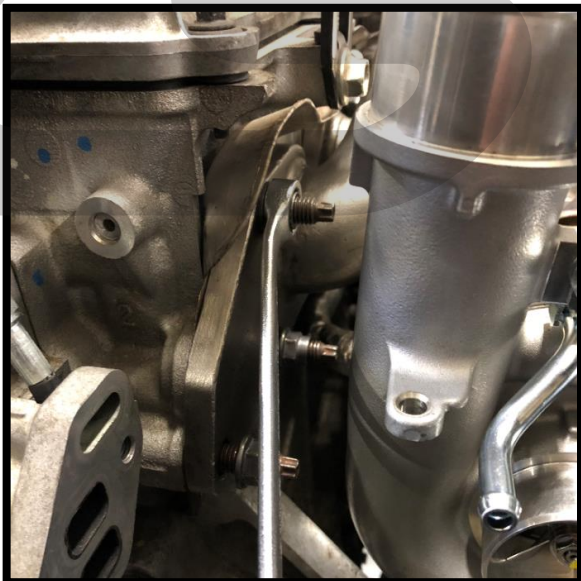

**Nut 8:** Basic 14mm wrench. Reach from driverside of car.

**DETAILED INSTRUCTIONS:**

**10. Installing the CorkSport Exhaust Manifold Main Section (cont.)**

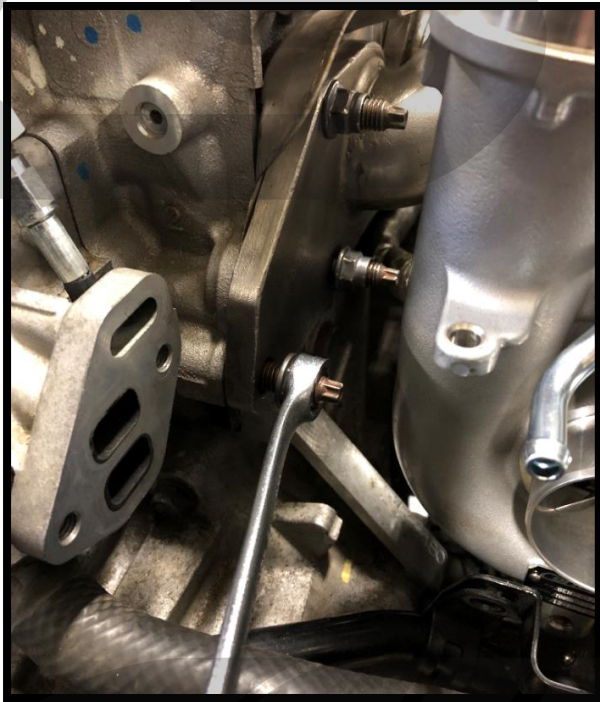

**Nut 9: Basic 14mm wrench. Reach from driverside of car.**

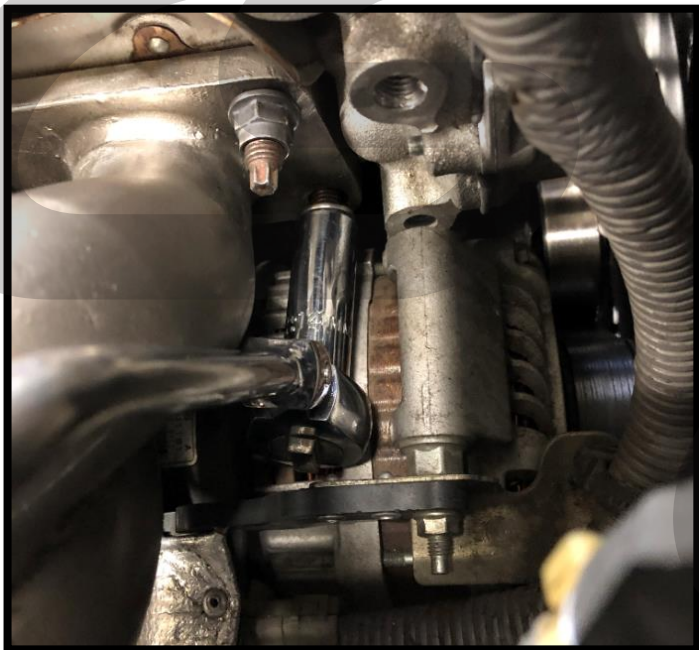

**Nut 10: Deep 14mm socket, ratchet.**

**DETAILED INSTRUCTIONS:****11. Installing the CorkSport Exhaust Manifold Elbow Section**

- a) **MAZDASPEED 3 OWNERS:** Install the supplied firewall heatshield to the OEM mounting locations using the supplied M6 nuts. Shown with install completed in **Figure 11a**.

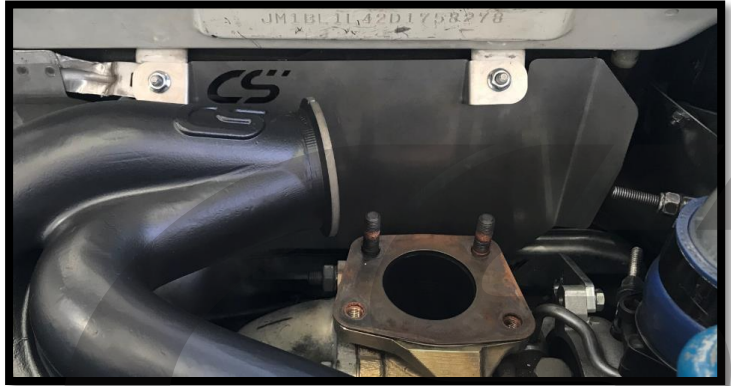
**Figure 11a**

- b) **MAZDASPEED 6 OWNERS (OPTIONAL):** Remove the small black tube coming off the firewall. Wiggle it back and forth as shown in **Figure 11b** until the spot welds break and the tube comes free from the firewall. This step is optional and the CS manifold will fit without removing this tube, however this tube may rest on the manifold elbow on some vehicles if not removed. Note: this tube is an inspection hole during vehicle assembly in the factory and serves no purpose.

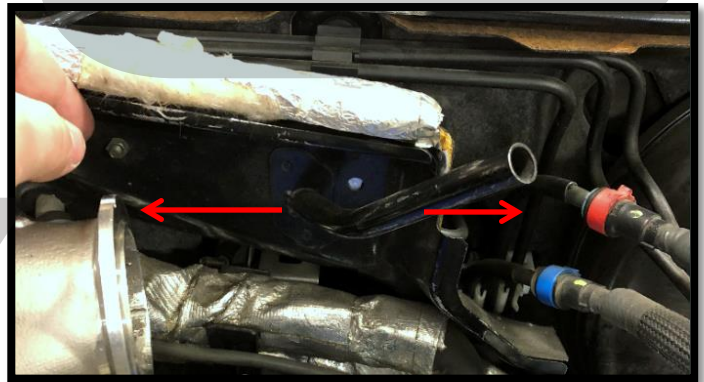
**Figure 11b**

- c) Place a supplied V-band clamp onto the main section of the CS exhaust manifold as shown in **Figure 11c**.

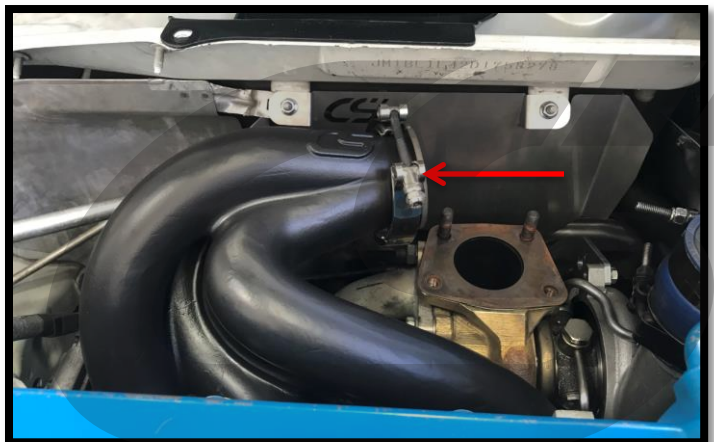
**Figure 11c**

**DETAILED INSTRUCTIONS:****11. Installing the CorkSport Exhaust Manifold Elbow Section (cont.)**

- d) Place the CS manifold elbow section onto the turbocharger studs. Finger tighten the rear left nut as you slide the elbow onto the studs as this nut has very tight clearances. Shown in **Figure 11d**.
- e) Install the remaining three OEM nuts to the CS manifold elbow and tighten all four nuts to **32-47ft-lbs**.
- f) Connect the main section of the CS manifold to the elbow section of the CS manifold using the V-band clamp installed earlier. Tighten the V-band clamp to **8-12ft-lbs**. Shown installed in **Figure 11e**.
- g) Retighten the three 14mm bolts on the turbocharger support bracket located underneath the turbo. These bolts were loosened in step 10c.

**Figure 11d****Figure 11e****NOTE**

Misalignment can occur between the V-band flanges of the CS exhaust manifold since everyone's setup is slightly different. Correct alignment of the V-band is shown in **Figure 11f**. If experiencing misalignment as shown in **Figure 11g**, you will need to shift your turbo position around, using the freedom gained from loosening the turbo support bracket in Step 10c.

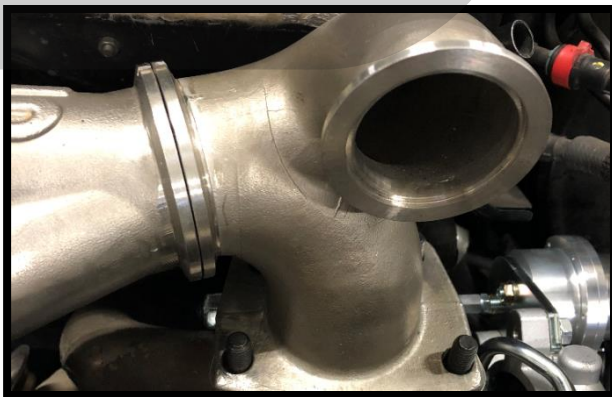
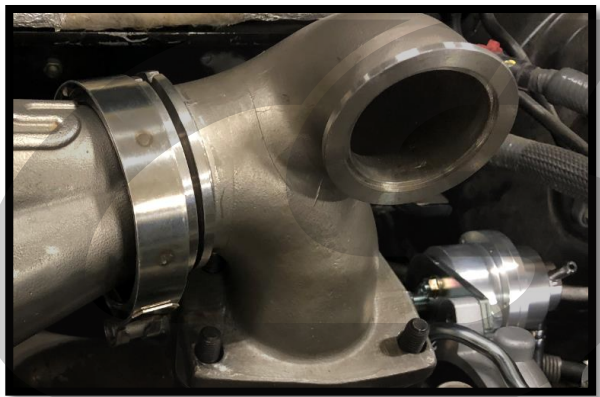
**Figure 11f****Figure 11g**

## **DETAILED INSTRUCTIONS:**

### **12. CorkSport Exhaust Manifold Setup for IWG**

**NOTE**

If using an external wastegate (EWG) skip to the next page.

- a) For use with internal wastegate (IWG), install a 44mm EWG block-off plate onto the open port of the CS exhaust manifold elbow. Secure using the a 44mm EWG clamp and tighten the clamp to **8-12ft-lbs**. Shown completed in **Figure 12a**.



**Figure 12a**



## **DETAILED INSTRUCTIONS:**

### **13. CorkSport Exhaust Manifold Setup for EWG**

**NOTE**

If using an internal wastegate (IWG) skip to page 36.

- a) For use with external wastegate (EWG), install your EWG onto the open port of the CS exhaust manifold elbow. Secure using the large clamp that came with your EWG. Leave the clamp loose so it will rotate during dump tube fitment. EWG shown installed in **Figure 13a**.



**Figure 13a**

**NOTE**

At this stage, if you did not purchase the CS dump tube, you will need to fabricate or purchase your own dump tube.

**NOTE**

The following images were shown on a bench engine for clarity. Installing the dump tube is a tight fit. Temporarily removing your primary O2 sensor will help with installation. If you have a downpipe with dual O2 sensor ports, typically the lower port will work better with the CS dump tube.

## DETAILED INSTRUCTIONS:

### 13. CorkSport Exhaust Manifold Setup for EWG (cont.)

- b) Insert the uppersection of the CS dump tube through the opening circled in red in **Figure 13a**. Work the dump tube around the downpipe until you can align it with the outlet of your EWG. Routing with a CS MS3 downpipe shown in **Figure 13b**.
- c) Attach the uppersection of the dump tube to the EWG using the smaller clamp that came with your EWG. Completed install shown in **Figure 13b**. Leave the clamp loose so that you can rotate the dump tube for best fitment.
- d) Slip the supplied dump tube clamp over the bottom of the upper dump tube section.
- e) MAZDASPEED 3 OWNERS: Slide the lower dump tube section into the upper dump tube section as shown in **Figure 13c**. The shorter end will fit into the upper dump tube section.
- f) MAZDASPEED 6 OWNERS: Slide the lower dump tube section into the upper dump tube section as shown in **Figure 13d**. The longer end will fit into the upper dump tube section.

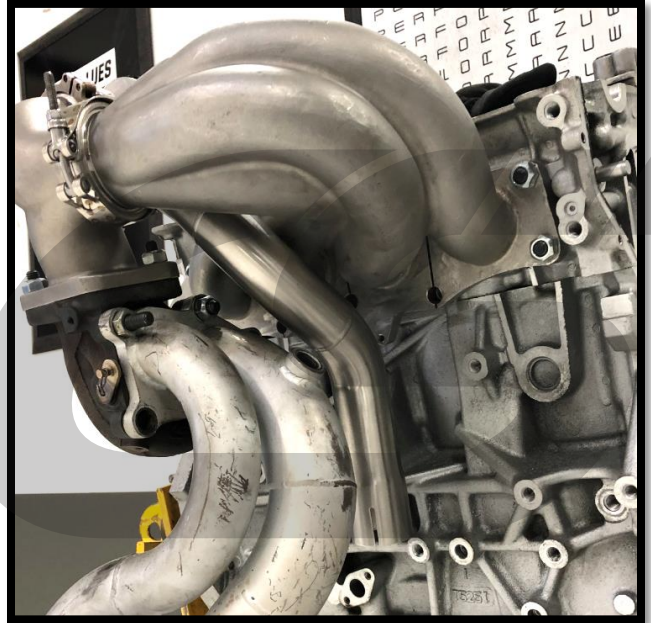

**Figure 13b**

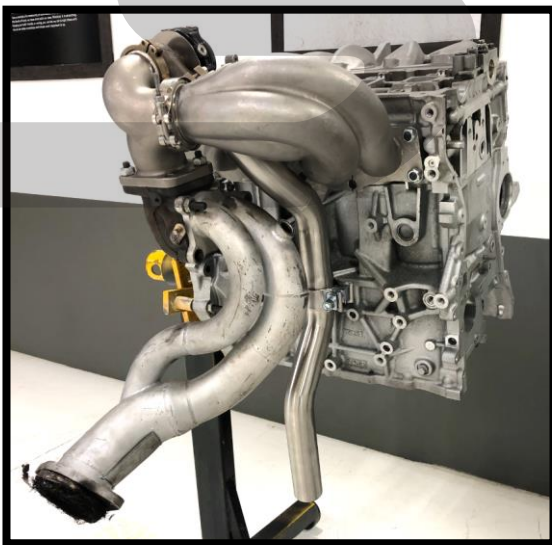

**Figure 13c**

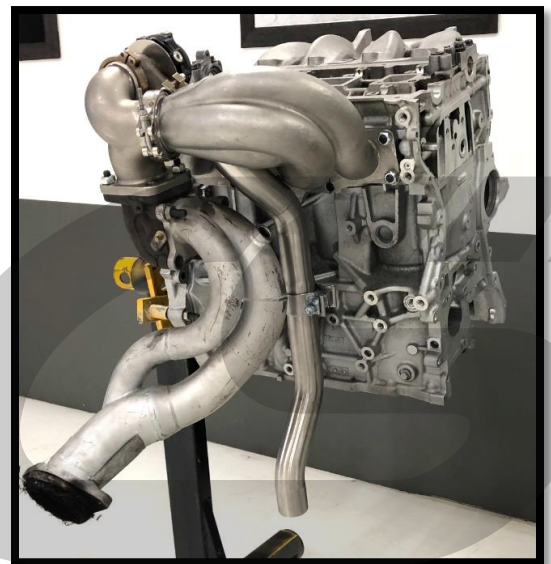

**Figure 13d**

**DETAILED INSTRUCTIONS:****13. CorkSport Exhaust Manifold Setup for EWG (cont.)**

- g) Rotate the EWG at the manifold, the EWG to upper dump tube section, and upper to lower dump tube connections until you are happy with fitment and have clearance to all components of the engine and chassis. The end of the CS dump tube should end up pointing out the bottom of your vehicle in a gap between your chassis and driveline components.
- h) Tighten the clamp at the manifold using a 3/16" Allen wrench and an 8mm socket. Tighten to **8-12ft-lbs.**
- i) Tighten the clamp at the outlet of the EWG using a 3/16" Allen wrench and an 8mm socket. Tighten to **8-12ft-lbs.**
- j) Tighten the clamp holding the upper and lower dump tube sections together using a 15mm socket. Tighten to **32-40ft-lbs.**
- k) Reinstall your engine undertray and determine where a hole must be cut for your dump tube. We recommend a generously oversized hole for a plastic skid tray to minimize melting. Metal skid trays can be cut much closer to the OD of the dump tube, but ensure you leave enough room for engine movement.

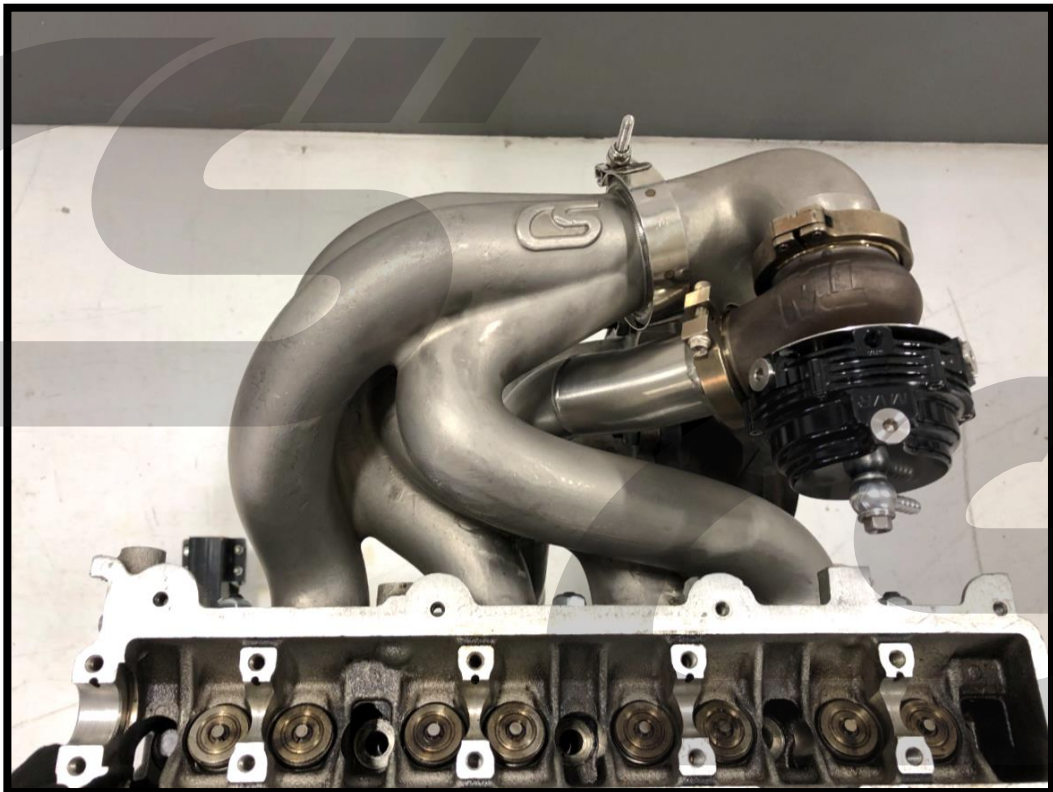

## DETAILED INSTRUCTIONS:

### 14. Vehicle Reassembly and First Startup

- a) Follow the instructions in reverse order to complete the vehicle assembly. Refer to torque specs below.
1. Reinstall the lifting eye and TMIC mounting removed in Section 9. If you loosened the turbo support bracket, be sure to retighten it.
  2. Reinstall the Turbine Heat shield removed in Section 8. Note, only the two lower bolts will now connect.
  3. Reinstall the Intercooler removed in Section 7.
  4. Reinstall the OEM turbo inlet pipe removed in Section 6.
  5. Reinstall the Battery and ECU removed in Section 5.
  6. Reinstall the intake and filter removed in Section 4
  7. Reinstall the cowl and hood removed in Section 1, 2, or 3.

b) Torque Specs:

- 8mm Nut/Bolt 8-10 ft-lbs
- 10mm Nut/Bolt 15-17 ft-lbs
- 12mm Nut/Bolt 19-21 ft-lbs
- 14mm Nut/Bolt 30-32 ft-lbs

 Before starting the vehicle, we recommend double checking all components that were affected during the manifold swap. Including boost reference lines.

 If you are moving to a new wastegate setup, ensure that all your boost reference lines are routed correctly per your tuner and that you have the correct tune for your new wastegate setup.

 The EWG flow is very efficient, typically we have found that a peak boost of 1.8 times the spring pressure can be achieved. Example: if a 20psi spring is installed in the EWG, peak boost pressure of 36psi can be achieved if the turbo can support that boost pressure.

 Even if you kept the same wastegate setup as before the CorkSport manifold install, we strongly recommend getting a retune to ensure safe engine operation with your new manifold.

- c) Start the vehicle. During first startup, listen for any strange noises, that may indicate an exhaust leak or other abnormalities that may indicate something was installed incorrectly.

 Smoke coming off the manifold during first start is normal. This is machining oil burning off of the manifold as it heats up for the first time.



This completes the installation of your CorkSport Exhaust Manifold. Listen for any strange noises during the first few drives. We also recommend a double checking V-band tightness after a few weeks of driving. Enjoy the added performance and great new sound!

## WHAT'S NEXT?

### CorkSport CST5 Turbocharger

Not too big, not too small. ITS JUST RIGHT for YOUR SPEED. Capable of built block power and extremely fast spool times, this turbo can make 500+whp and hit 20psi by 3500-3600rpm. The CorkSport CST5 turbo can be tuned for a more laid-back curve that is stock block safe or pushed to 30+psi for built blocks and auxiliary fueling. No matter what build you have this turbo will be sure to impress. The CST5 features a MHI Journal Bearing CHRA, 0.82 Turbine A/R and 4" Anti-Surge Compressor Cover. The CST5 turbo is available in two boost control setups: Internally Wastegated (IWG) & 44mm Externally Wastegated (EWG) w/included EWG elbow pipe & V-band clamp.

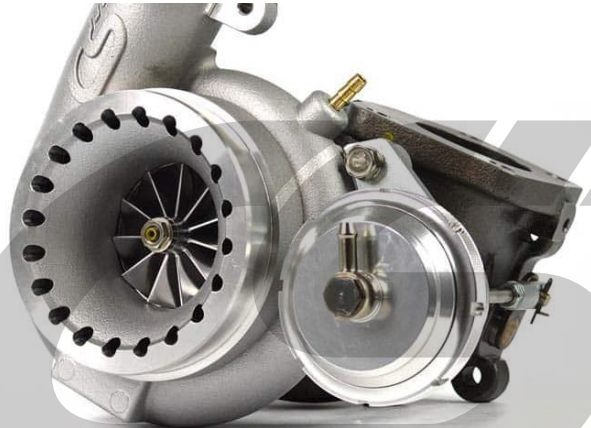

### CorkSport 13" Big Brake Kit

The Stage 2 CorkSport 13" Big Brake Kit for Mazdaspeed 3 provides a drastic improvement to braking by offering improvements to each component in the system.

Larger rotors, 4-piston calipers, stainless steel brake lines, upgraded pads, and everything you need to install on your Speed 3 is included in this kit. If the CorkSport Big Brake Caliper Kit was not enough for you and your MS3, look no further than the CorkSport 13" BBK.



### CorkSport Adjustable Rear Swaybar

Remove the tendency to overpower the front tires under hard cornering and minimize traction robbing body lean with the CorkSport Mazdaspeed 3 Rear Adjustable Sway Bar. Compressing inside suspension, the CorkSport Mazdaspeed 3 Rear Sway Bar effectively increases the spring rate on side of the suspension which is compressed most and its adjustability allows you to fine tune the handling. Each Mazdaspeed3 swaybar includes machined 6061-T6 aluminum swaybar brackets which are more durable than the stamped steel design common with other swaybars and look sharp with an anodized black finish.

